



CURENT Overview 2023-2024

Kevin Tomsovic and Fran Li

CURENT Annual Industry Conference

April 29 and May 1, 2024

Knoxville, TN



Northeastern



Rensselaer

TUSKEGEE

Brief History of CURENT (1)

- Selected by National Science Foundation (NSF) and Department of Energy (DOE) from a few hundred proposals across all engineering disciplines.
- First and still the only ERC devoted to power transmission systems.
- Center began Aug. 15th 2011; Graduated Nov. 2021.
- Industry partnership program (34 members as of Spring 2024).
- Total funding since inception >\$100M (core and other projects).
- Broadening research mission since graduation.

Brief History of CURENT (2)

- **Research**

- Annual expenditures around \$6-8M after graduation in 2021.
- Annual publications more than 100.

- **Industry and innovation**

- 34 industry members (~\$700K/year). More than 30 members since 3rd year.
- Over 60+ patent applications since inception.

- **Infrastructure**

- Unique testbed facilities (Hardware Testbed and Large-scale Testbed), FNET, MW universal power tester and other lab facilities
- Extensive real-time simulation capabilities; extensive power system simulation facilities – ANDES (CURENT developed), DigSilent, GridDyn, OPAL-RT, PSS/E, PowerWorld, PSLF, RTDS, TSAT and others



Brief History of CURENT (3)

- **Education**

- Over 150 Ph.D. and 100 MS graduates since inception
- Worked with 120 cumulative Research Experience for Undergraduates (REUs) among which 49% were underrepresented minority (URM).
- Over 80% of Young Scholar Program (YSP) participants since inception have gone on to major in engineering or science fields



- **Awards and Recognition**

- Recognized as one of the top power and energy research Centers in the world.
- Core power faculty includes: 4 NAE members, 10 IEEE Fellows, Governor's Chair, 2 Chancellor Professors, 7 named professorships.
- Numerous (too many to count) best/prize paper awards for our students and faculty.

Annual Highlights – Overall

- Research expenditure: \$6M in AY23
- Publications: 100+ journal and conference papers
- Patents: 13 awarded
- 24 PhD and 10 MS graduated

Annual Highlights – Honors (1)

- **National Academy of Engineering (NAE) Members:** Kevin Tomsovic and Ali Abur (NEU)
- **IEEE Fellow:** Kai Sun
- **IEEE Power Electronics Society (PELS) Milan M. Jovanović Award for Power Electronics Emerging Technology:** Leon Tolbert
- **IEEE PELS Richard M. Bass Outstanding Young Engineer Award:** Daniel Costinett
- Other university-level awards: 5





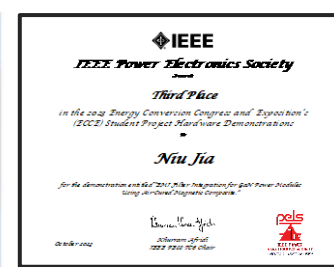
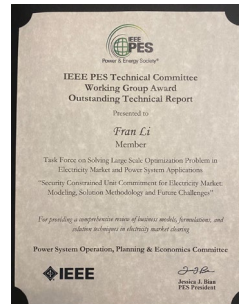
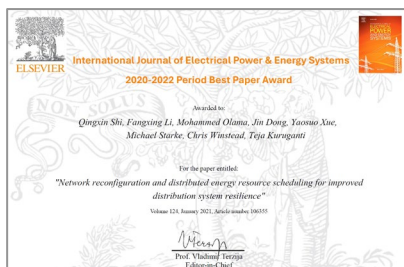

Annual Highlights – Honors (2)

- **8 Best/Prize Papers, 1 Best Technical Report, 1 Best Demo. Project, and 1 Best Presentation**
 - **IEEE PES Technical Committee Prize Paper award 2024:** Fran Li
 - **Best Paper Award for 2020-2022 Period, awarded in 2024 by I. J. of Electrical Power & Energy Systems:** Fran Li
 - **Best Graduate Student Paper Award at NAPS 2023:** Nicholas Parsly (GRA), Jinning Wang (GRA), and Fran Li
 - **IEEE PES Technical Committee Best Technical Report in 2023:** Fran Li
 - **Outstanding Papers of IEEE Transactions on Power Systems in 2023:** Kai Sun
 - **Prize Conference Paper Award (Best of the best papers), IEEE PES GM23:** Kai Sun
 - **Best Paper Award for 2023, Solar Energy Journal:** Yilu Liu
 - **Best Paper - 3rd Place, IEEE Texas Power and Energy Conference, 2024:** Yilu Liu
 - **First Place Prize Paper Award, IEEE Power Electronics Letters, 2023:** Zheyu Zhang
 - **3rd Place at Student Hardware Project Demonstration, ECCE 2023:** Niu Jia (GRA, advisor: Leon M. Tolbert)
 - **Outstanding Presentation, APEC 2024:** Zihan Gao (GRA, advisor: Fred Wang)



Annual Highlights – Significant New Projects (1)

- **Integrated Three-level GaN Inverter and PMSyn RM Motor for Electric Passenger Vehicles and Medium/heavy duty Trucks (GaNIn_PMSynRM)**
 - Federal share (DOE/VTO) \$5M, cost share \$1.25M, **Total \$6.25M**
 - Lead PI and organization: **Kevin Bai**, The University of Tennessee, Knoxville
 - Use GaN for an 800V inverter, adopt less rare earth for the motor, and integrate inverter and motor for an efficient and affordable powertrain for electric vehicles
 - Partners:     



UTK integrated GaN power modules



| ETDS Targets | | | |
|----------------------|------|------|----------------------|
| Year | 2020 | 2025 | Change |
| Cost (\$/kW) | 8 | 6 | 25% cost reduction |
| Power Density (kW/L) | 4.0 | 33 | 88% volume reduction |

<https://www.energy.gov/sites/prod/files/2017/11/f39/EETT%20Roadmap%2010-27-17.pdf>

Annual Highlights – Significant New Projects (2)

- A UNIVERSAL (Ultrafast, Noise-Immune, Versatile, Efficient, Reliable, Scalable, and Accurate Light-controlled) Switch Module
 - Federal share (ARPA-E) \$2.7M, cost share \$0.8M, **Total \$3.5M**
 - Lead PI and organization: **Fred Wang**, The University of Tennessee, Knoxville
 - The project will develop a 20 kV/250A optically controlled and sensed switch module with LEGO-like scalability. The switch module has overall efficiency >99.9%, can turn off 2500 A instantaneous current, achieve >500V/ns and >200A/ns slew rates, and survive >30,000 cycles. It will help to enable fast and accurate protection needed for future power electronics dominated power systems.
 - Partners:

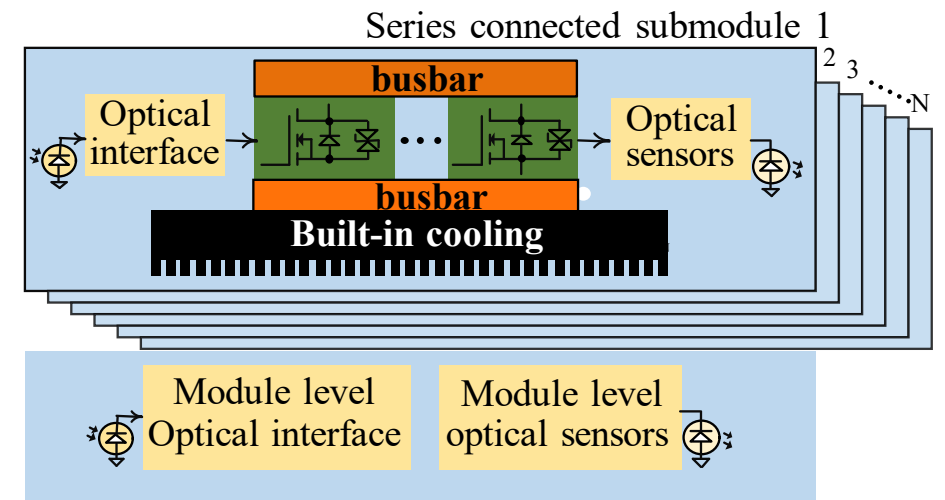

Annual Highlights – Significant New Projects (3)

- **A Community Co-Designed Weatherization and Microgrid Plan for Equitable Energy Security and Environmental Health**
 - Funded by Wellcome Trust, **Total 1.7M**
 - Lead PI: **Chien-fei Chen**, Co-PIs: M. Jin, **L. M. Tolbert**, and researchers at UNMC, Harvard
 - This project aims to provide climate mitigation solutions, i.e., community microgrids and weatherization with electrification for reducing energy burdens and GHG and improve physical and mental health for underserved communities.

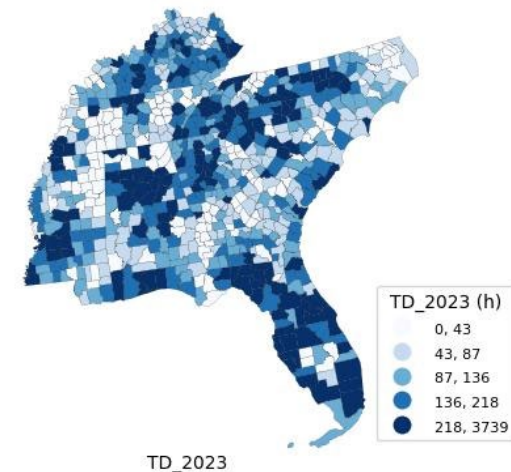
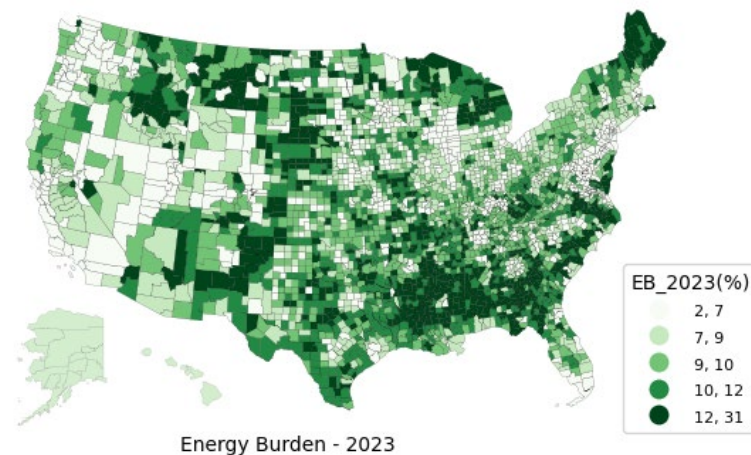

Annual Highlights – Significant New Projects (4)

- **An Equitable, Affordable & Resilient Nationwide Energy System Transition (EARNEST)**
 - Funded by DOE/Stanford, UTK share of DOE funding: \$1M, Cost Share 250K, **Total 1.25M**
 - Site PIs/: **Fran Li, Yilu Liu**
 - Study resilience enhancement and economic benefit near low-income communities using integrated energy microgrid system (IEMS) in southeastern region under extreme weather
 - Broad impact: 2633 landfills in the US, 622 in the southeast region, and 129 in Tennessee.

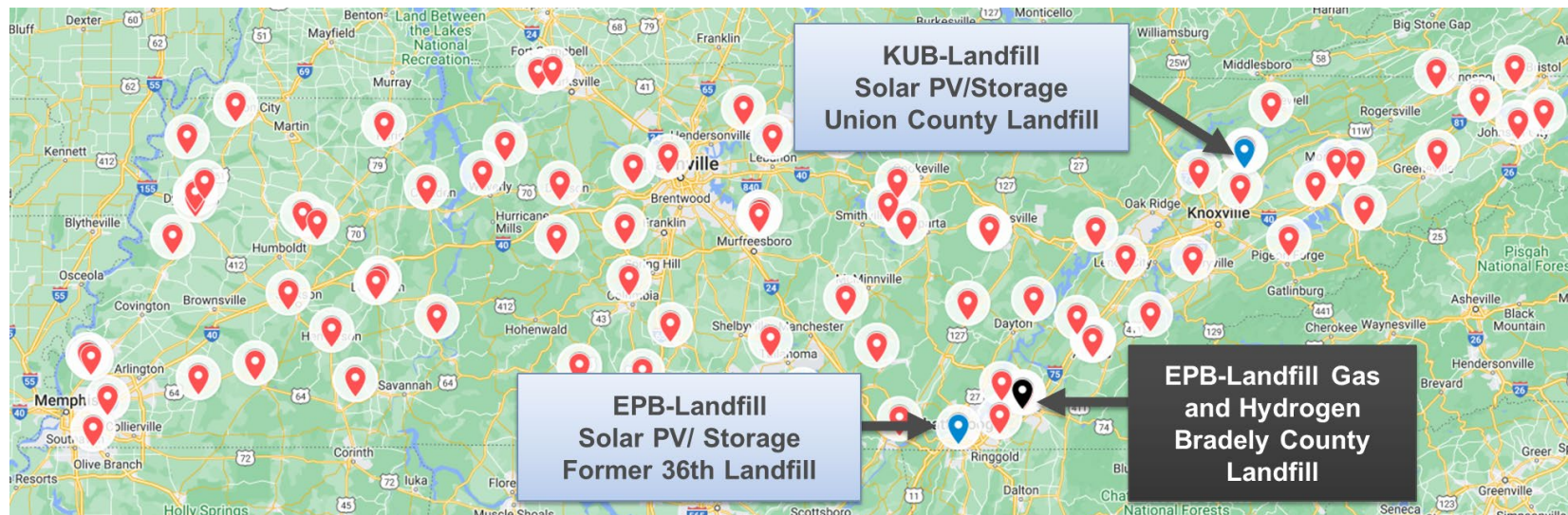

Annual Highlights – Books & Significant Publications

• 4 Books

- **F. Wang, Z. Zhang, R. Chen**, *Design of Three-phase AC Power Electronics Converters*, Wiley-IEEE Press, 2024, ISBN 978-1119794233.
- **F. Li** and Y. Du, *Deep Learning for Power System Applications – Case Studies Linking Artificial Intelligence and Power Systems*, Springer, ISBN 9783031453571, November 2023.
- **K. Sun** (editor), *Cascading Failures in Power Grids: Risk Assessment, Modeling, and Simulation*, Springer, 2024. ISBN:978-3-031-47999-1.
- **K. Sun** (editor), *Power System Simulation Using Semi-Analytical Methods*, Wiley-IEEE Press, 2023. ISBN:978-1-119-98801-4.

• 3 papers at *The Proceedings of the IEEE*

- F. Li, K. Tomsovic, C.-F. Chen, J. Chow

• Magazine Cover Article

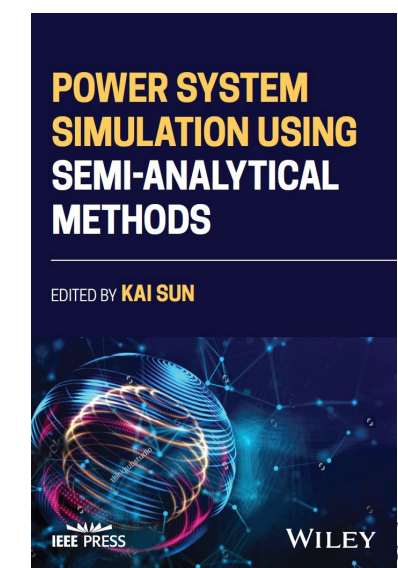
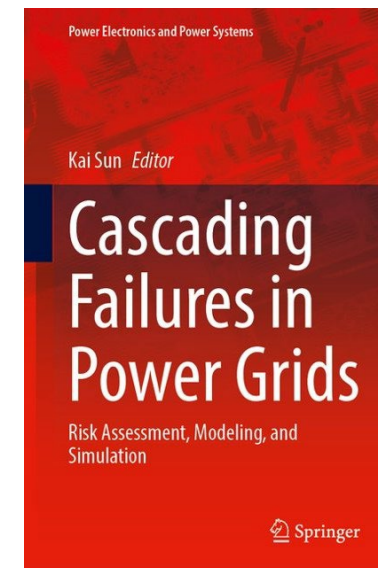
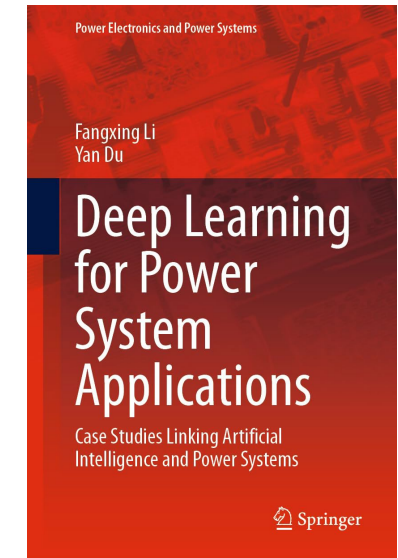
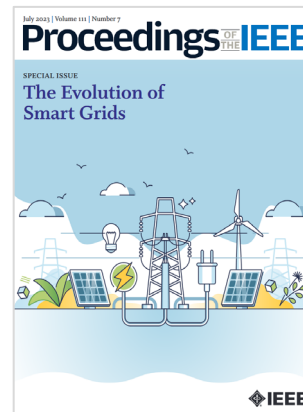
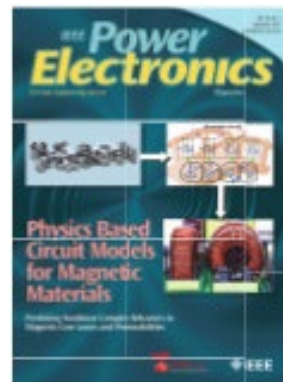

Annual Highlights – Significant services

- Fran Li is the Editor-In-Chief of *IEEE Open Access Journal of Power and Energy (OAJPE)*
- Leon Tolbert is the Academic Deputy Editor-In-Chief of the *IEEE Power Electronics Magazine* and chair of publications department for the IEEE Industry Applications Society (IAS)

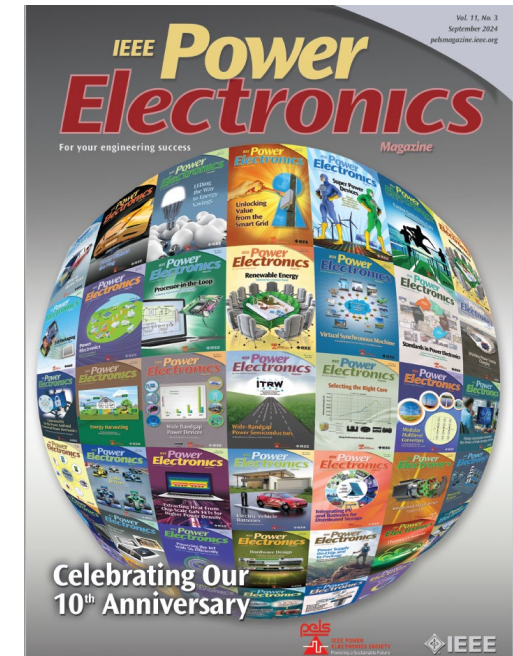

CURRENT Facilities – At Min Kao Building

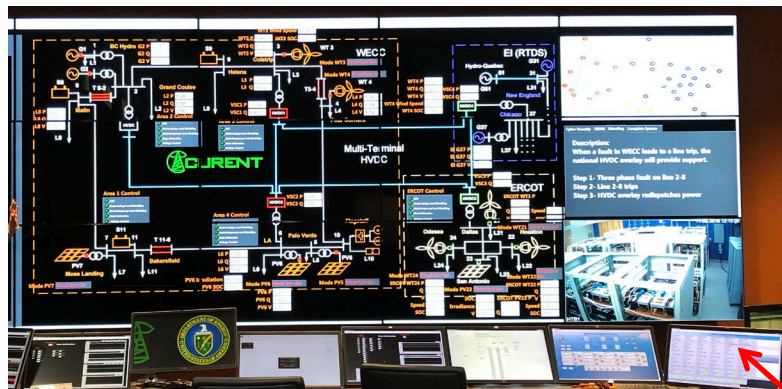

Visualization and Control Lab



Low and Medium Power Lab

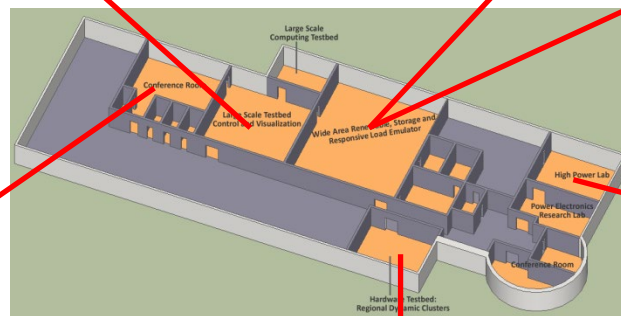

Conference Room



High Power Lab

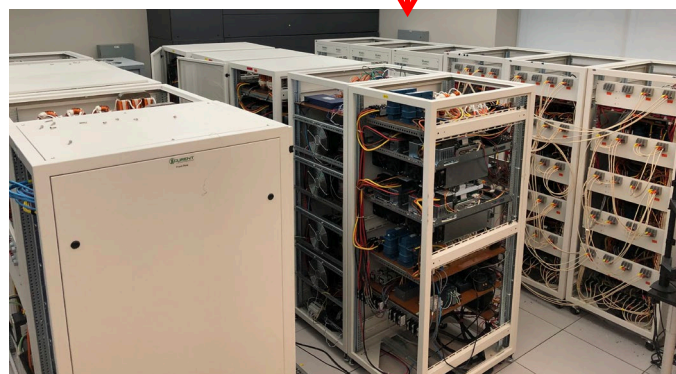

Grid Emulation Lab

CURRENT Facilities - Testbeds

- **Largescale Testbed (LTB):**
Closed-loop Virtual Grid Simulator with an Energy Management and Control System. Four packages: ANDES, AMS, AGVis, and DiME. Also interfaced with external tools. Web: <https://ltb.curent.org/>

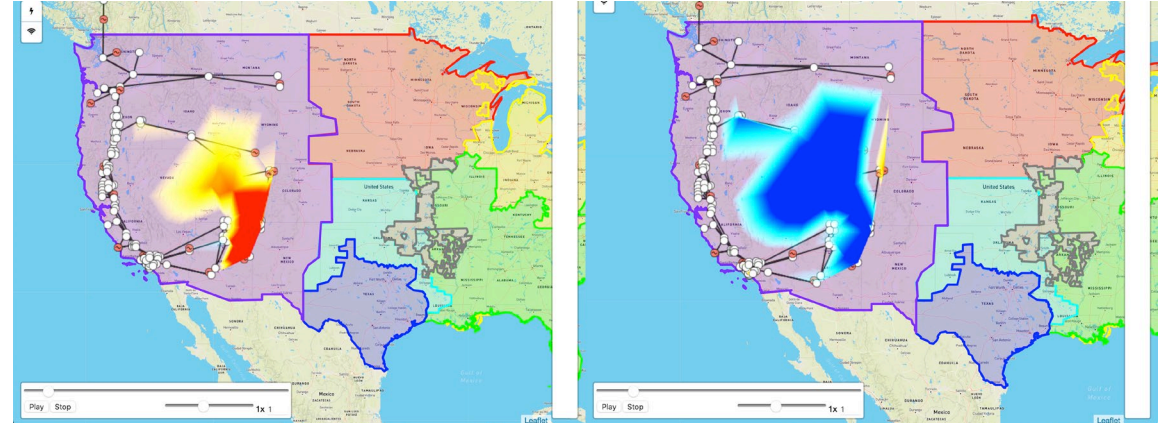

- **Hardware Testbed (HTB):**
Grid Emulator Development and Real-time Scenario Demonstration

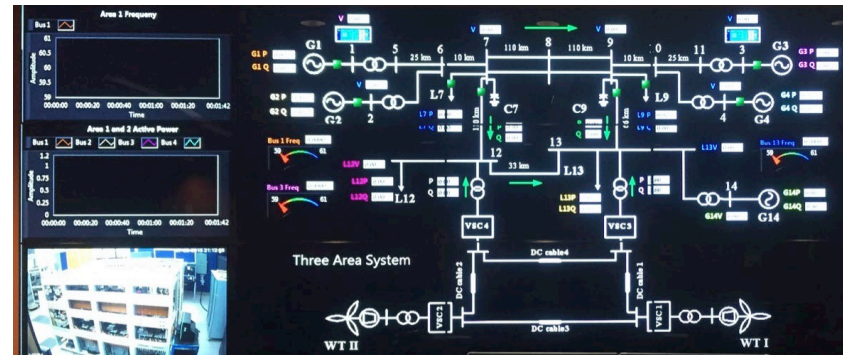

CURRENT Facilities - FNET/GridEye

FNET GridEye

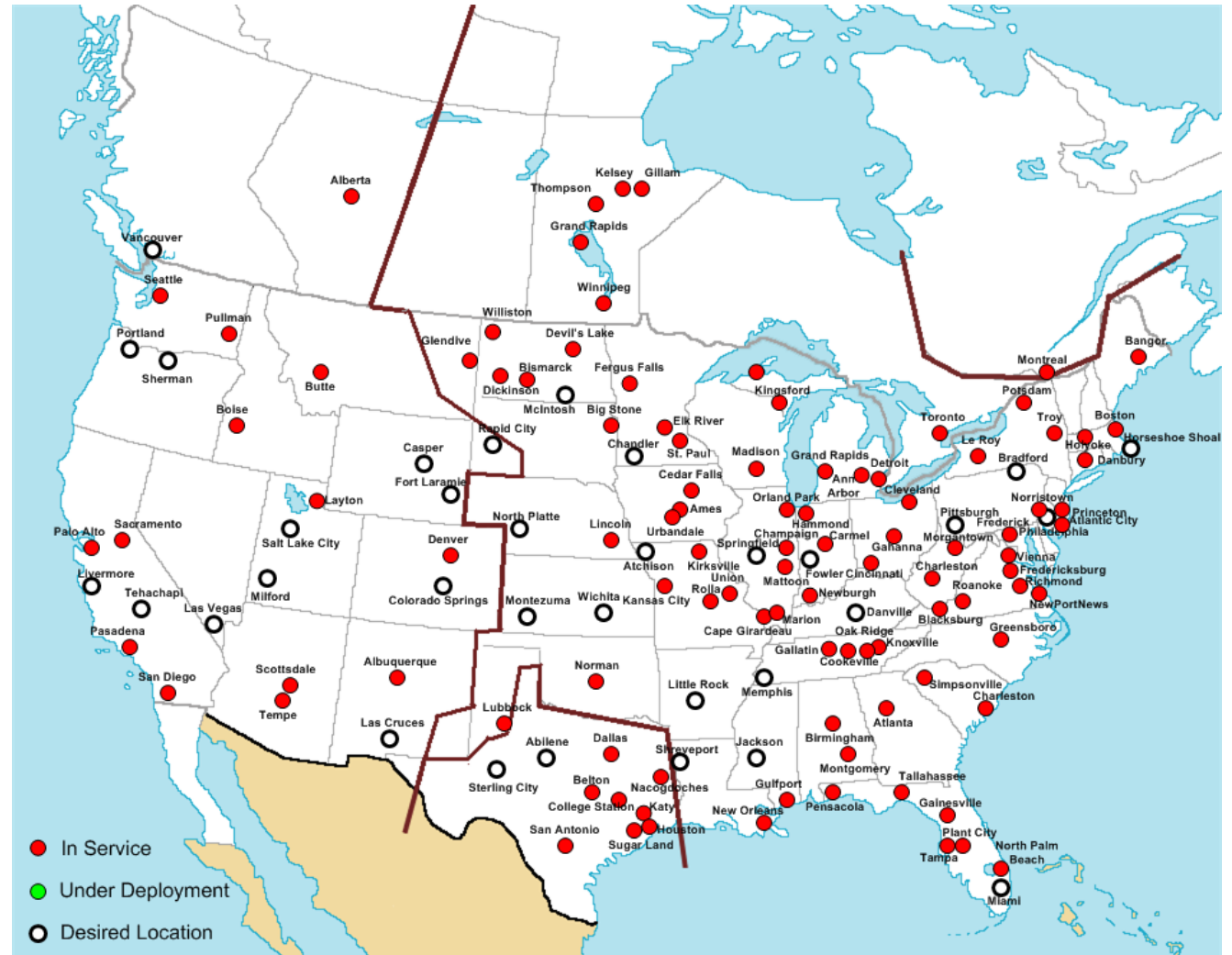
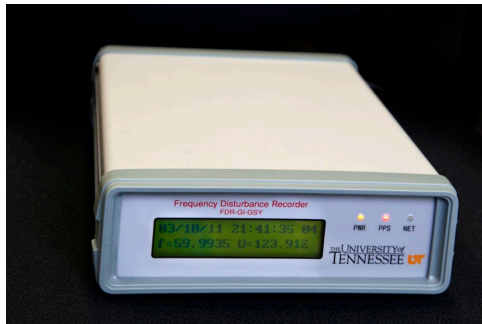

CURRENT Research Scope

Original Vision

- Monitoring, modeling, control and actuation of a nation-wide transmission grid for high efficiency, high reliability, low cost, better accommodation of renewable sources, full utilization of storage, and responsive load.

Expanded Scope

- Transmission & distribution grids
- Microgrids
- Energy storage
- Electrification of transportation and other systems
- AI applications for electrical systems
- Power electronics components, converters, & systems
- Interdisciplinary study related to energy, climate change, sustainability, and social justice.

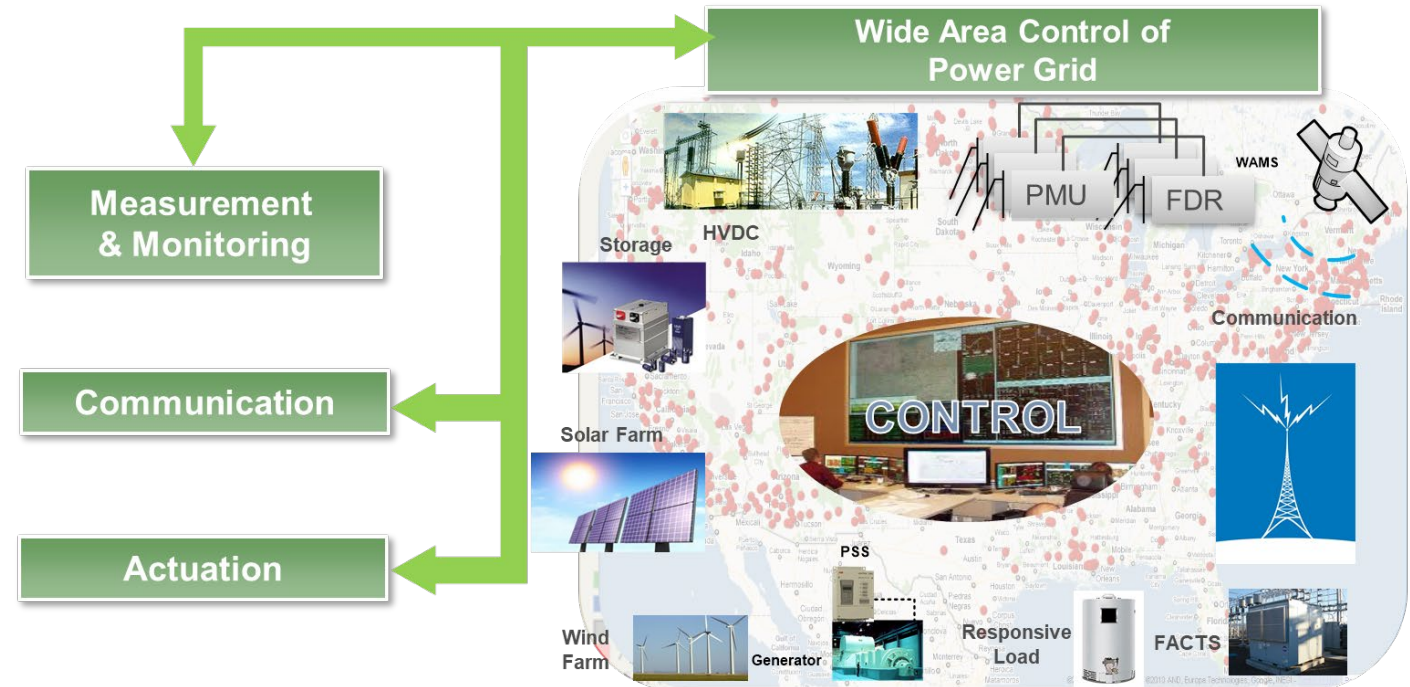

Industry Program



Thank you!
Q & A

Backup Slides

Future Support for Sustainability

- External projects and grants
 - ❖ DOE, NSF, NASA, DOD, DOJ, etc.
 - ❖ Industrial members
- State and university supports
- Expanding partner and affiliated universities
- Growing testbeds
 - ❖ Playing a vital role for future proposals, contracts and projects
 - ❖ LTB: donation account being setup (open-source communities); service and maintenance contracts; supporting projects in multiple infrastructures
 - ❖ HTB: smaller and more modular converters for better scalability.

Research Plans

- **Research portfolio**
 - ❖ Responsive to industry members and other funding sources
 - ❖ Maintain identity and build on research strengths
- **Vision:** Emphasize unique expertise in power systems and power electronics
 - ❖ Enhancing existing research areas
 - Extend system into **distribution and microgrid systems** (small commercial and residential)
 - Increased emphasis on **cybersecurity and other resilience issues** of national concern
 - Data-driven system approaches using **artificial intelligence**
 - **Electrification of transportation:** high-power-density, high-efficiency, cyber secured extremely fast charging stations, V2X applications (X= grid, home, load, vehicle, etc.)
 - ❖ Exploring new research directions without losing focus
 - Operation of fully inverter-based systems, such as, **aircraft powered, ships, microgrids,** etc.
 - Power system interfaces to **other infrastructures – e.g., buildings, transportation, gas networks**
 - Interdisciplinary study related to energy, **climate change, sustainability, and social justice.**

Faculty Achievement – Honors (2)

• 8 Best/Prize Papers, 1 Best Technical Report, 1 Best Demo. Project, and 1 Best Presentation

- ❖ **IEEE PES Technical Committee Prize Paper award 2024**, W. Wang, X. Fang, H. Cui, **F. Li**, Yijing Liu, and Thomas Overbye, “Transmission-and-Distribution Dynamic Co-Simulation Framework for Distributed Energy Resource Frequency Response,” *IEEE Transactions on Smart Grid*, January 2022.
- ❖ **Best Paper Award for 2020-2022 Period, awarded in 2024 by International Journal of Electrical Power & Energy Systems**: Q. Shi, **F. Li**, M. M. Olama, Jin Dong, Yaosuo Xue, Michael Starke, Chris Winstead, and Teja Kuruganti, “Network reconfiguration and distributed energy resource scheduling for improved distribution system resilience,” volume 124, Article# 106355, *International Journal of Electrical Power & Energy Systems* (Elsevier), January 2021.
- ❖ **Best Graduate Student Paper Award at NAPS 2023**: N. Parsly, **J. Wang**, N. West, Q. Zhang, H. Cui, and **F. Li**, “DiME and AGVIS: A Distributed Messaging Environment and Geographical Visualizer for Large-scale Power System Simulation,” *55th North American Power Symposium (NAPS)*, Ashville, NC, USA, October 15-17, 2023, pp. 1-5.
- ❖ **IEEE PES Technical Committee Best Technical Report in 2023**: PES Technical Report "Security Constrained Unit Commitment for Electricity Market: Modeling, Solution Methodology and Future Challenges" (**F. Li** as a co-author).
- ❖ **Outstanding Papers of IEEE Transactions on Power Systems in 2023**: X. Xu, W. Ju, B. Wang, **K. Sun**, "Real-time Damping Estimation on Nonlinear Electromechanical Oscillation," *IEEE Transactions on Power Systems*, vol. 36, No. 4, pp. 3142-3152, July 2021.
- ❖ **Prize Conference Paper Award (Best of the best papers)**: Bin Wang, Dan Wu, Xiaowen Su, **K. Sun**, Le Xie, "A Long-Term Voltage Stability Margin Index Based on Multiple Real Power Flow Solutions," *IEEE PES General Meeting*, Orlando, FL, July 16-20, 2023
- ❖ **Best Paper Award for 2023, Solar Energy Journal**: Wei Qiu, Liang Zhang, He Yin, Dahan Liao, Lawrence C. Markel, Ben W. McConnell, **Y. Liu**. “Modeling, testing, and mitigation of electromagnetic pulse on PV systems,” Volume 264, 2023 Solar Energy.
- ❖ **3rd Place - Best Paper**: **Y. Liu** and students, Samuel Okhuegbe and Adedasola Ademola, “A Machine Learning Initializer for Newton-Raphson AC Power Flow Convergence” at the IEEE Texas Power and Energy Conference on February 13, 2024.
- ❖ **First Place Prize Paper Award, IEEE Power Electronics Letters, 2023**: L. Ravi, D. Zhang, D. Qin, **Z. Zhang**, Y. Xu and D. Dong, “Electronic MOV based voltage clamping circuit for DC solid-state circuit breaker applications," *IEEE Transactions on Power Electronics*, vol. 37, no. 7, pp. 7561-7565, July 2022.
- ❖ **3rd Place at Student Hardware Project Demonstration**: IEEE PELS Energy Conversion Congress and Exposition, **Niu Jia** (advisor: **L. M. Tolbert**), “EMI Filter Integration for GaN Power Modules Using Air-Cured Magnetic Composite.” October 2023, Nashville, TN.
- ❖ **Outstanding presentation, Zihan Gao** (advisor: **F. Wang**), “A Compact Power Stage Design for 10-kV SiC Device-Based Converters with Heatsink Electric Field Shaping”, APEC 2024, Long Beach, CA.

CURRENT Large-scale Testbed (LTB)



Project Objectives

- To develop a **closed-loop platform** that includes both dynamic and dispatch/market simulation
- To enable **dispatch-dynamic interfaced co-simulation**

Recent Achievements

- Created [Homepage](#) for CURENT LTB
- Created [Linkedin Account](#) for CURENT LTB
- AMS development, benchmark, and release
- AGVis backend improvement with web application

Hybrid symbolic-numeric power system modeling and simulation

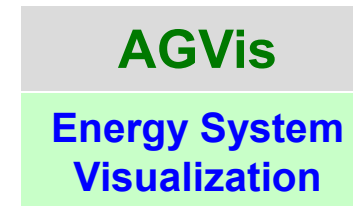
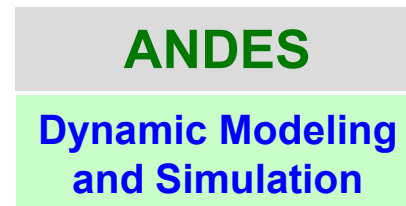

Geographical visualization for energy system



Best Graduate Paper Award, NAPS 2024

Dynamic information interfaced scheduling modeling and simulation

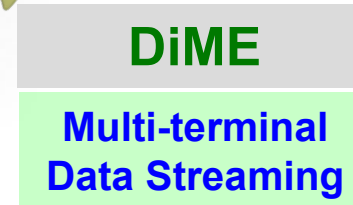
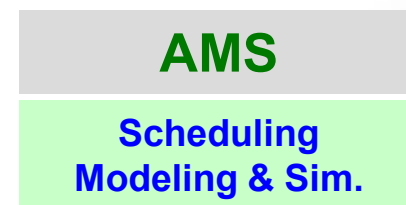

Data messaging between multiple power system components

Inverter-Based Hardware Testbed (HTB)

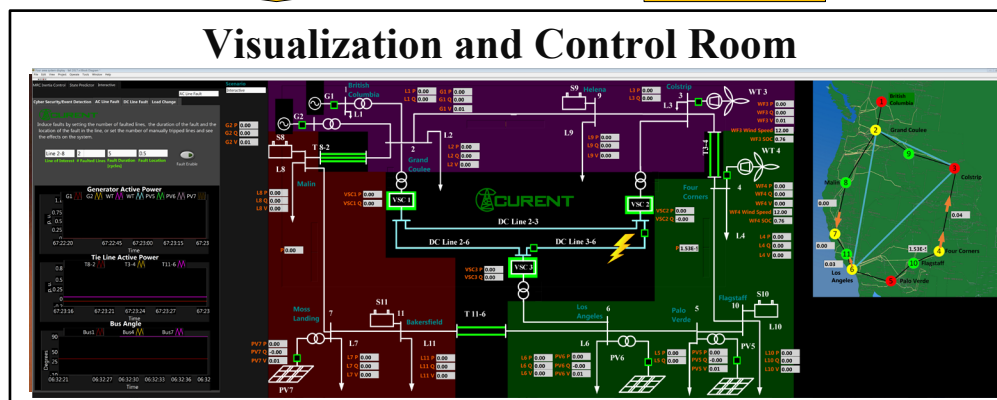
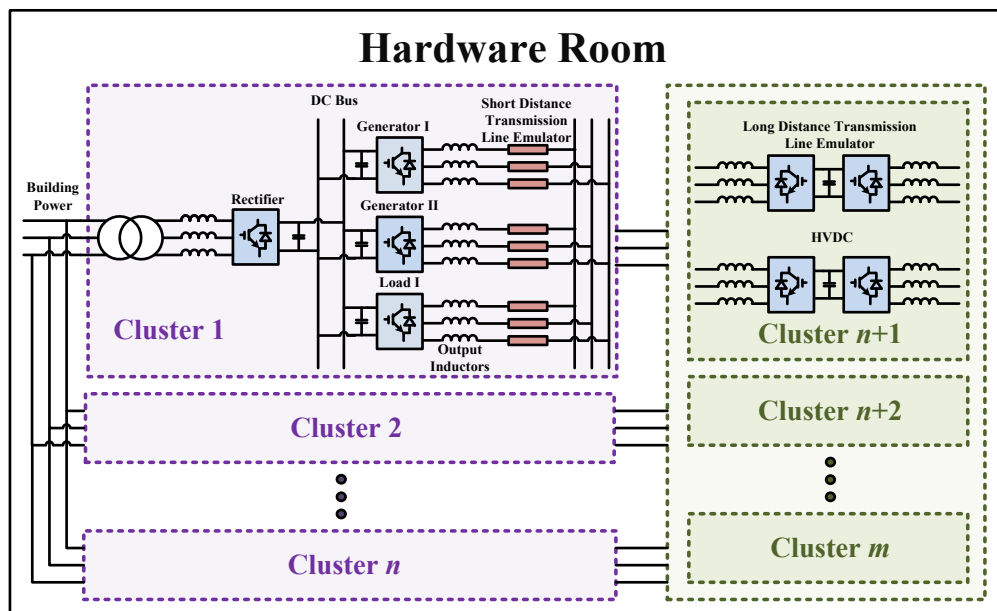

- Real three-phase power flow with inverters emulating generation, load, storage, and AC or DC transmission lines
- Actual/realistic control, measurement (CTs, PTs, PMUs), and communication

HTB System Control Architecture

Monitoring (Blue)
 Modeling (Orange)
 Control (Green)
 Actuation (Red)

Central control

- Visualization
- System reconfiguration
- Scenario/event selection
- Operator emulation

Interconnection control

- Info exchange
- Cascaded failure control

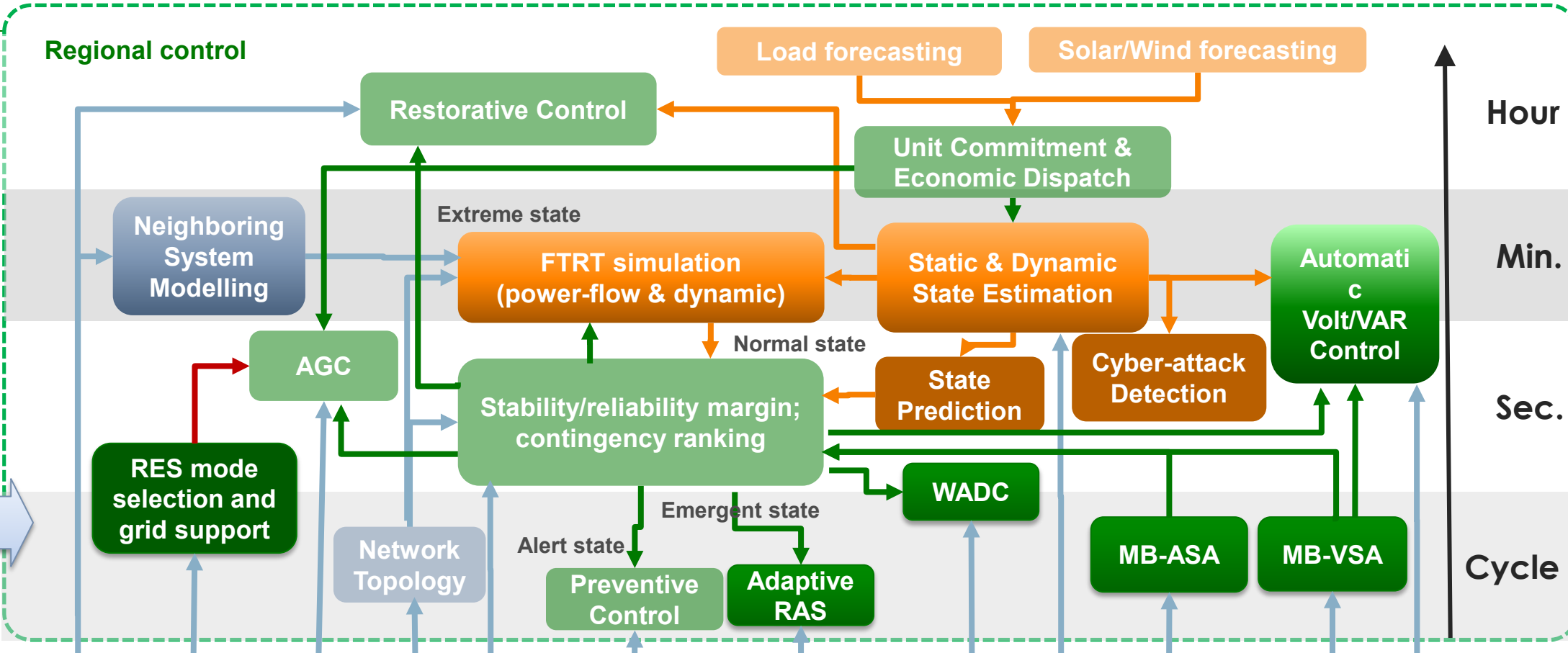

Measurement and Data Acquisition System (e.g. SCADA, PMU, FDR)

